



M0404



9261

Litho-Mounted Corrugated Packaging



M0184

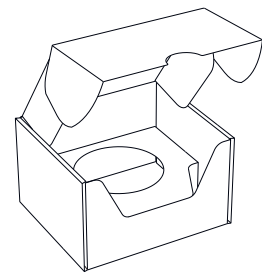

M0472 5-1/2" W x 4-3/4" x 3" D
Custom Insert Designed to Hold Baseball
Rollover Sides with Tuck Tab Closure

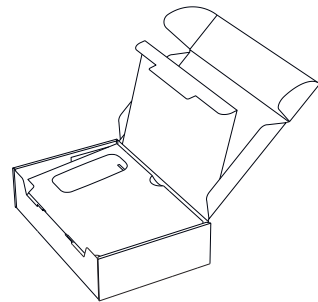

M0404 10" W x 6-1/2" H x 2-1/2" D
Display Box with Custom Platform

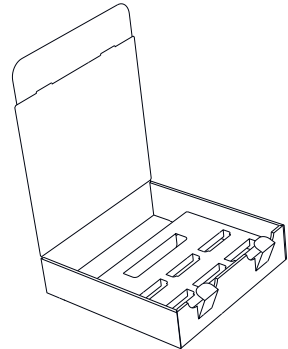

M0508 10" W x 10" H x 2.5" D
Front Tuck & [2] Locking Tabs
and Custom Insert

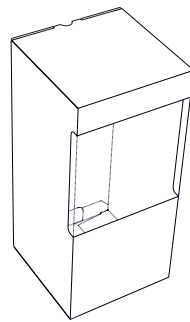

M0405 6" W x 13" H x 6" D
w. 6" x 6" Clear Plastic Window

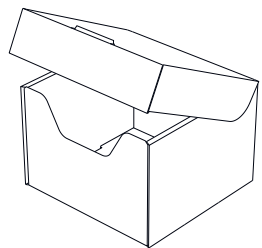

M0063 7" W x 6-3/4" H x 4-15/16 D
Dip Cut Front Panel
With Rollover Lid

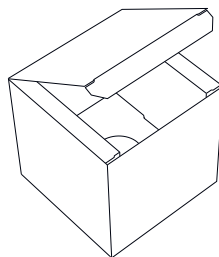

M0273 7" W x 7" H x 7" D
Lip Flap Insert
Option for Custom Paper,
Corrugated, or Foam Insert

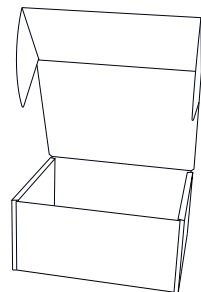

M00336D 4-3/4" W x 4" H x 2-3/8" D
Econo Style, 2 Side Rollover
with Cover Flaps

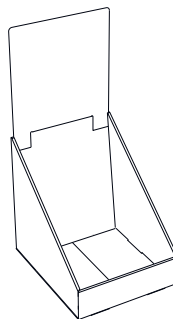

M0629 9-3/4" W x 8-1/8" H x 9-3/4
POP Counter Display

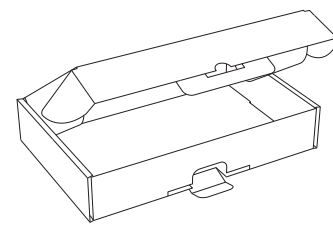

9273 7-3/4" W x 5-1/4" H x 1-1/2" D
Box with Mailer Lock

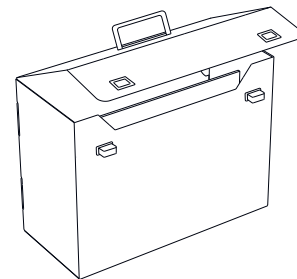

M0365 13-1/4" W x 10" H x 6" Capacity
6" Capacity Tote Box
Twist Locks and Plastic Handle

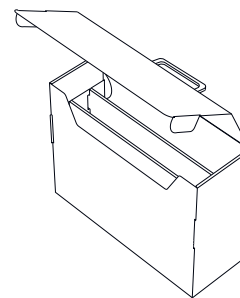

M0103 13" W x 10-1/2" H x 4-1/2" D
Corrugated Inserts/Dividers to Hold
Tabs & Contents: Die # M0213

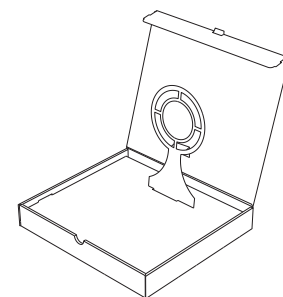

M0537 10-1/2" W x 9-1/2" H x 1-1/2" D
Die Cut Corrugated 'Target' Pop-Up
Tuck Tab Close with Thumb Notch

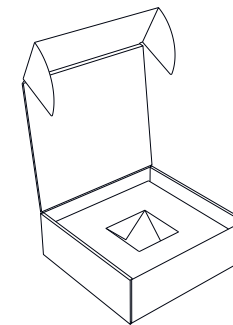

M0407 8" W x 8" H x 2-7/8" Capacity
2 Side Rollover Ear Flap Tuck Tabs

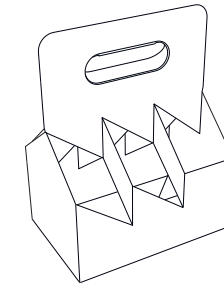

9261 9-1/4" W x 6-1/4" H x 9-1/12"
'6-Pack'

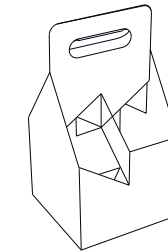

M0276 8-1/2" W x 5-5/8" H x 11-1/4" D
'4-Pack'

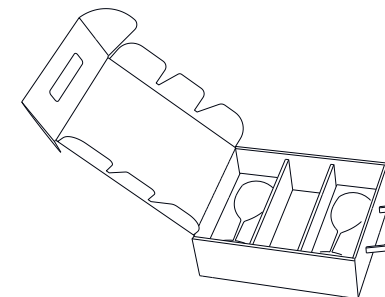

M0565 9-3/4" W x 11-3/4" H
2-3/4" Capacity
Litho Mounted Corrugated Display
Box with Custom Wine Glass Insert

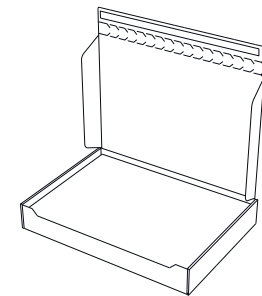

M0344 13-1/2" W x 9-1/2" H x 2"
Litho Mounted Corrugated Mailer
with Zip Strip

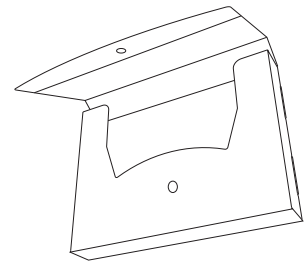

M0250 12" x 9" H x 1-5/8" Capacity
Front Flap with Magnet
Closure

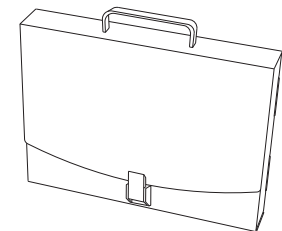

M0395 12" W x 9" H
1-3/4" Capacity
12" W x 8-1/5" H Flap with
Plastic Clip Closure & Plastic Handle

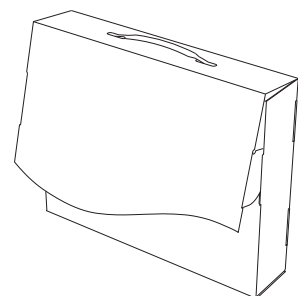

9316 12" W x 10" H
2-1/2" Capacity
12" W x 7-1/5" H Flap with
Double Magnet Closure
Tuck Tabs & Plastic Handle



CMYK:11% 100% 49% 01%

Litho-Mounted Corrugated Packaging

Litho-Mounted Corrugated Packaging [Continued]



M0082 10-3/4" x 7-3/4" x 3"
2 Side Rollover w. Cover Flaps & Ears

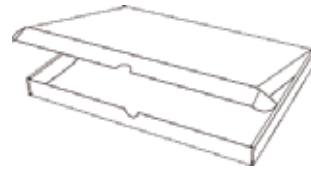

M0066 12-1/2" x 10" x 1"
2 Side Rollover w. Cover Flaps & Ears

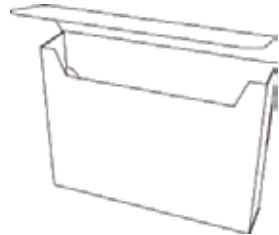

M0037 12-1/2" x 9-1/2" x 2-1/2"
Side Locking Tab Tote

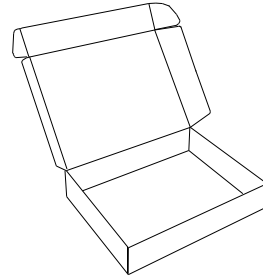

M0014 14-1/8" x 11-1/8" x 2-13/16"
2 Side Rollover w. Cover Flaps & Ears

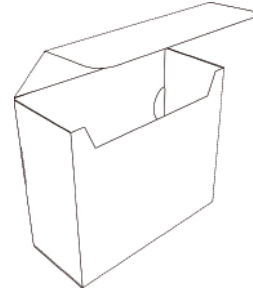

M0071 12" x 10-9/16" x 5-1/16"
Side Locking Tab Tote
Closure Options

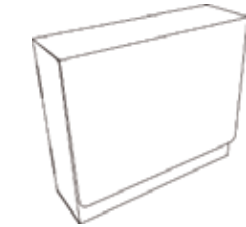

M0051 12-1/2" x 9-1/2" x 2-1/2"
Side Locking Tab Tote



M0054 12-3/16" x 11-15/16" x 5-1/8"
Die Cut Handle Holes

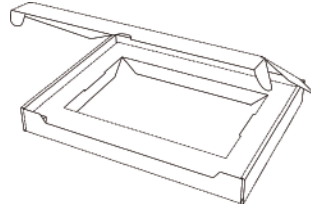

M0072 11-1/8" x 8-5/8" x 1-3/8"
2 Side Rollover w. Cover Flaps & Ears
Custom Insert

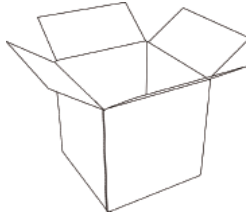

M0059 5-15/16" x 5-15/16" x 5-7/8"
Die Cut Regular Slotted Container [RSC]



M0069 11-1/16" x 6-7/8" x 5-5/8"
Econo Style, 2 Side Rollover

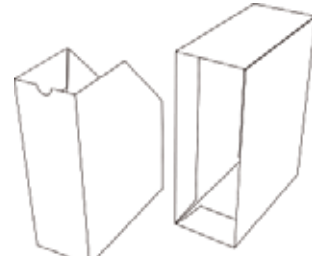

M0056 9-3/4" x 12-1/4" x 4-7/16"
Wedge & Slipcase



M0073 13" x 7" x 1-3/4"
2 Side Rollover w. Front Tuck
Super Panel on Inside Lid
Custom Insert

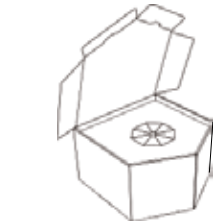

M0076 7-1/16" x 7-5/16" x 4-1/16"
Multi Side Rollover w. Cover Flaps
Aperture to Hold Baseball

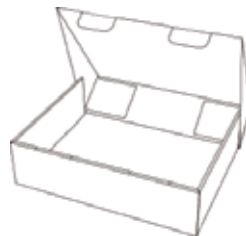

M0060 13-1/16" x 10" x 3-7/16"
Tab Locks
2 Side Rollover w. Fixed Cover Flaps



M0064 6-3/16" x 4-3/16" x 2-1/8"
Econo Style, 2 Side Rollover
with Cover Flaps



M0472



M0508



M0537

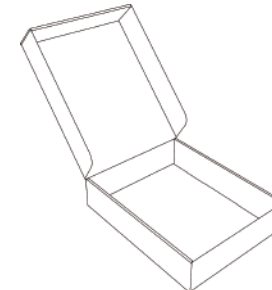

M0061 11-1/16" x 8-5/8" x 2-1/2"
1 Side Rollover Lid
2 Side Rollover Base



M0077 12" x 9-1/2" x 1-1/2"
2 Side Rollover w. Cover Flaps & Ears

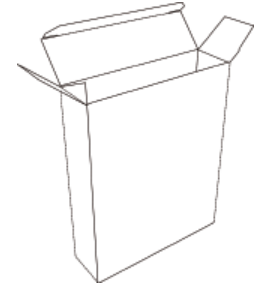

M0098 7-15/16" x 2-1/4" x 9-13/16"
Tuck End Carton Style

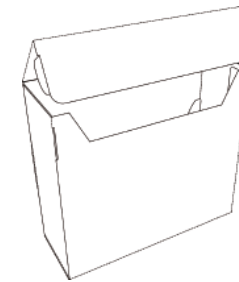

M0092 10-11/16" x 11-5/8" x 2-1/4"
Side Locking Tab Tote
Front Flap with Locking Tabs



M0078 6" x 6" x 6"
Lip Flap Inserts, Hollow Side Walls

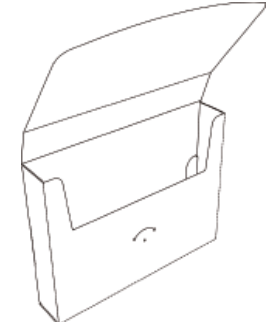

M0084 9-9/16" x 12-5/16" x 2-1/16"
Side Locking Tab Tote
Half Moon Front Flap
Velcro Closure Suggested



M0079 20-1/16" x 7-3/8" x 4"
2 Side Rollover w. Front Tuck
& Locking Tab
Optional Custom Insert

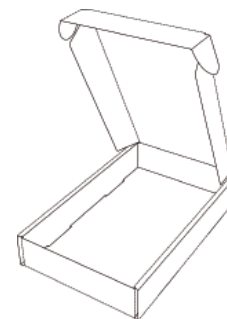

M0065 12-1/4" x 7" x 2"
2 Side Rollover w. Cover Flaps & Ears



M0081 16" x 11-3/16" x 2"
2 Side Rollover w. Front Tuck
Custom Insert

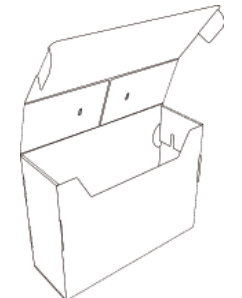

M0103 10" x 13" x 4-1/2"
Front Flap w. Locking Tabs
Side Locking Tab Tote
Reinforced Handle Area